

VORTRAN LASER TECHNOLOGY, INC

STRADUS® 685-40



The Stradus® diode laser module is a fully integrated, plug and play, and self-contained laser module. The patented sealed optical cavity and the innovative electronics give the Stradus® laser unparalleled power stability, beam pointing stability, and low noise over time and temperature. Vortran's Graphical User Interface (GUI) software allows the user to control and monitor the module remotely via USB or RS-232.



Wavelength (nm)	685 ± 10
Power Output (mW)	40 (-0%, +10%)
Spatial Mode	TEM ₀₀
Small Beam (mm, mrad)	~1.1, ~1.0
Standard Beam (mm, mrad)	~1.4, ~0.6
M ² (typical)	< 1.25
Beam Circularity	> 90%
Beam Centration (mm)	< 0.5
Beam Alignment (mrad)	< 5
Pointing Stability (µrad/°C)	< 5
Power Stability (over 24 hours)	< 0.5%
Polarization Orientation	Vertical ±2°
Polarization Extinction Ratio	>100:1
RMS Noise (10Hz to 10MHz)	<0.2%
Digital Modulation	200MHz
Digital Rise Time	< 2nsec
Modulation Depth	∞ (full off)
Analog Modulation	500kHz
Analog Rise Time	< 0.7 µs
Input Power (Head)	12V DC, 1.5A (max)
Input Power (Control Box)	90-250 VAC, 50/60Hz
Storage Temperature	-10°C to +60°C
Operating Temperature	+10°C to +45°C
Laser Head Weight	210g
Communication	Mini-USB and RS-232
CDRH Class	Class IIIb
ESD Protection	Class 4
EU Compliance	CE Mark Certified with control box
RoHS Compliance	EU and China

- **Medical, Biomedical & Industrial**
- **Patented Sealed Optical Cavity**
- **Self-contained & Compact**
- **Excellent Beam Quality**
- **Low Noise**
- **USB or RS-232 Interface with GUI**
- **Analog & Digital Modulation**
- **OEM Head or End-user Systems**

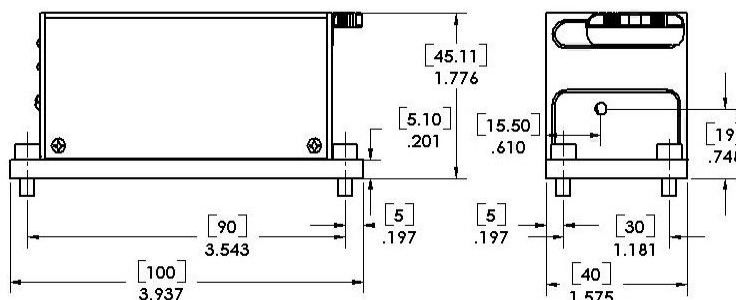

Graphical User Interface Software

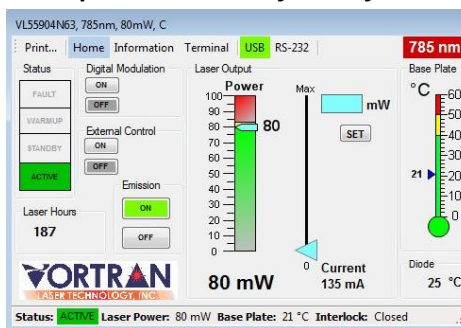

www.frlaserco.com
sales@frlaserco.com

Am den 30 Morgen 13
D-61381 Friedrichsdorf
Phone +49 6172 27978-0
Fax +49 6172 27978-10



Note: Specifications guaranteed only at full power