



FPYL-532-50T-SLM-C

Wide Temperature Range Single Frequency DPSS Laser

Specifications

Wavelength (nm)	532±1
Output Power (mW)	>50
Transverse Mode	TEM ₀₀
Longitudinal Mode	Single
Operating Mode	CW
Power Stability (RMS, over 4 hours)	<1%
Noise of Amplitude (RMS, 1Hz – 20MHz)	<0.25%
Warm-up Time (minutes)	2~3
M ² Factor	<1.2
Beam Divergence (full angle) (mrad)	≤1.5
Beam Diameter at the Aperture (1/e ²) (mm)	≤0.8
Spectral Width (FWHM) (nm)	<0.00001
Polarization Ratio	>100:1 (Horizontal ±5 degree)
Power Consumption (W)	<220 (@-40°C)
Laser Head Dimensions (mm)	110 x 52 x 52
Operating Temperature (°C)	-40 ~ +60
Storage Temperature (°C)	-40 ~ +60

Laser Head Drawing (with RS232)

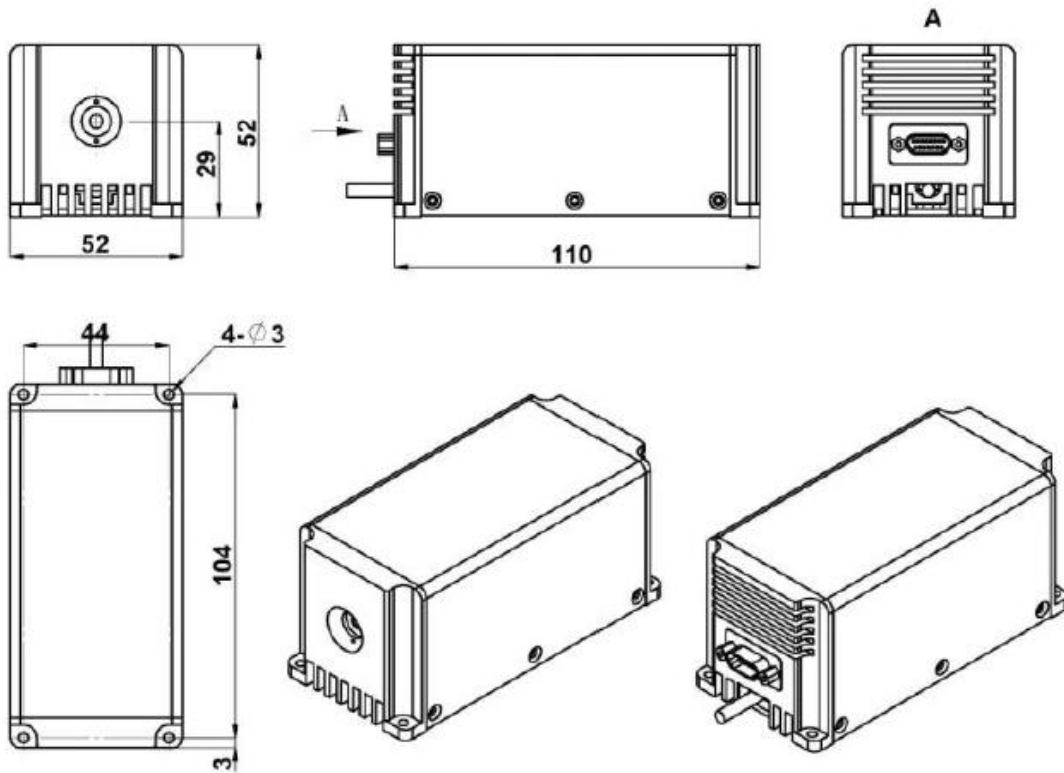

Laser Head Drawing (without RS232)

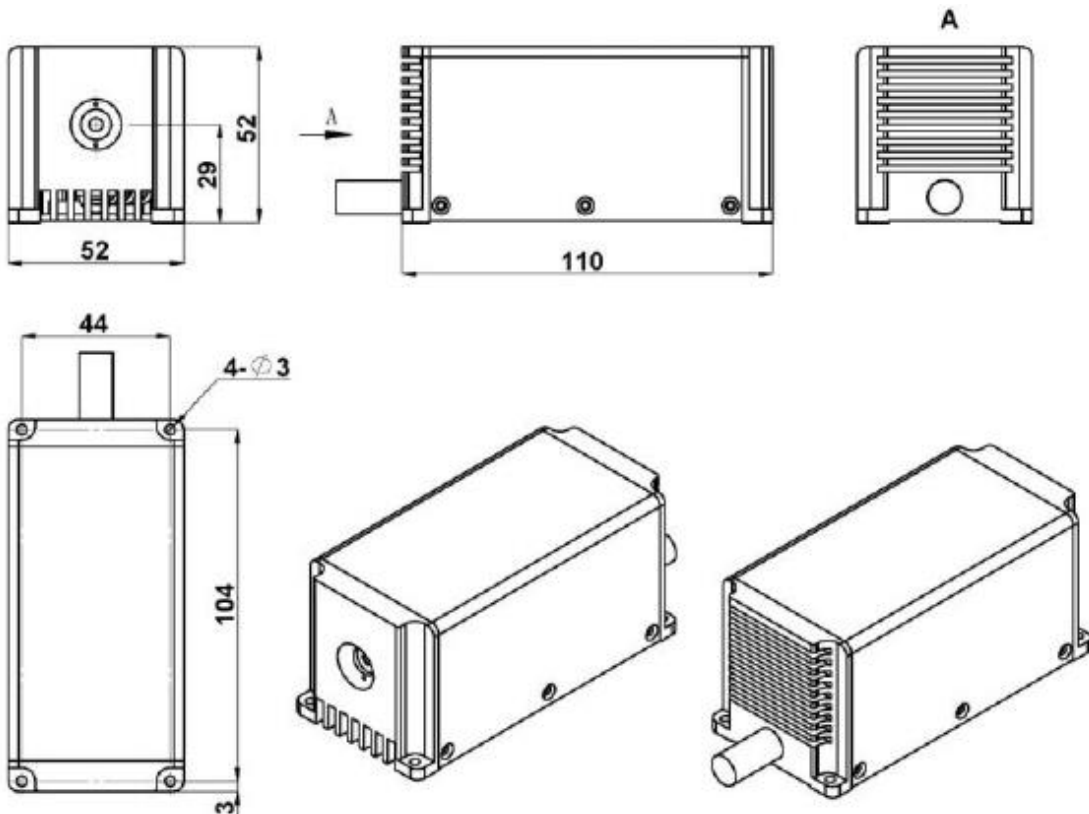

Sample Test Results

- Power stability
@-40°C power stability 0.149%



- Power stability
@60°C power stability 0.234%

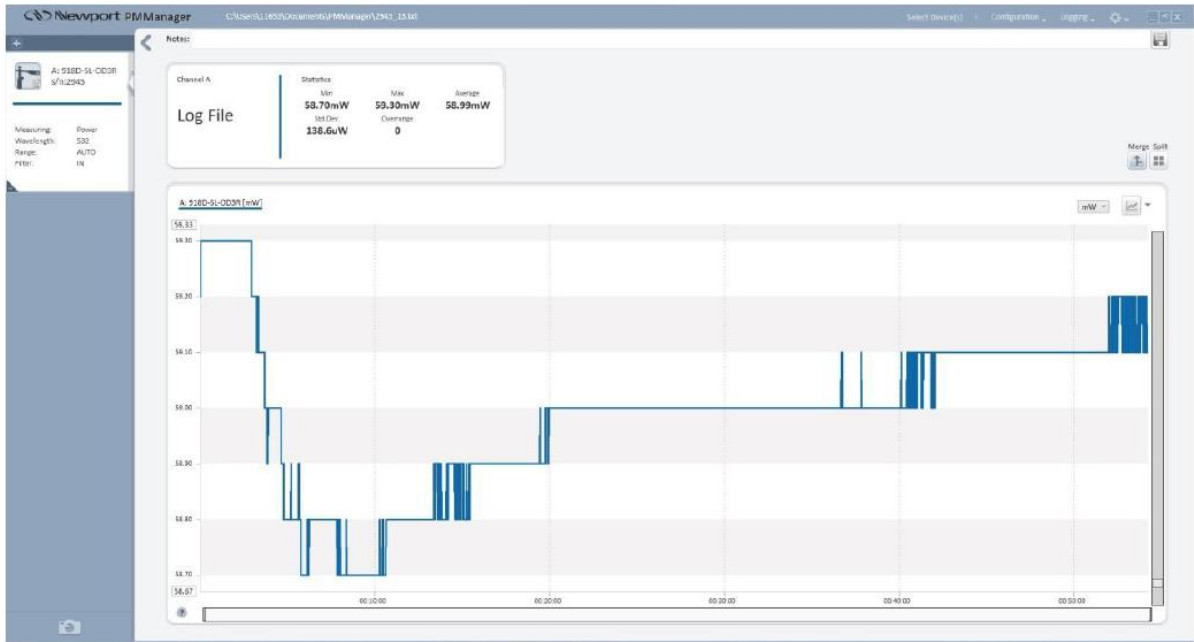

- power stability testing at ultimate temperature with 2h storage
-40°C power stability after storage for 2hrs

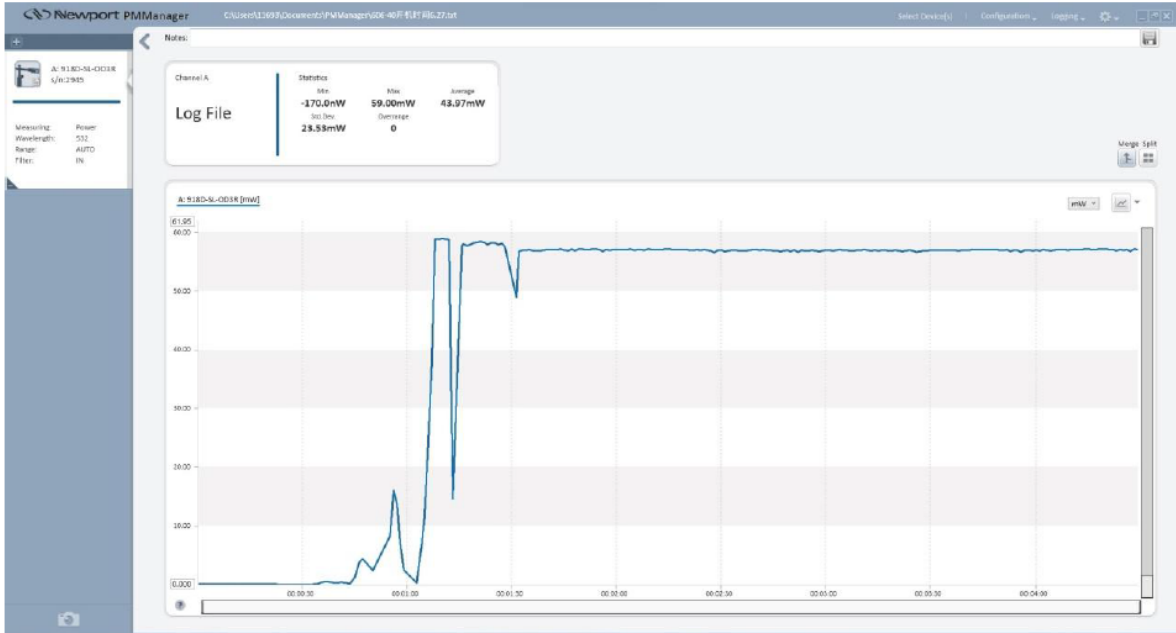

60°C power stability after storage for 2hrs

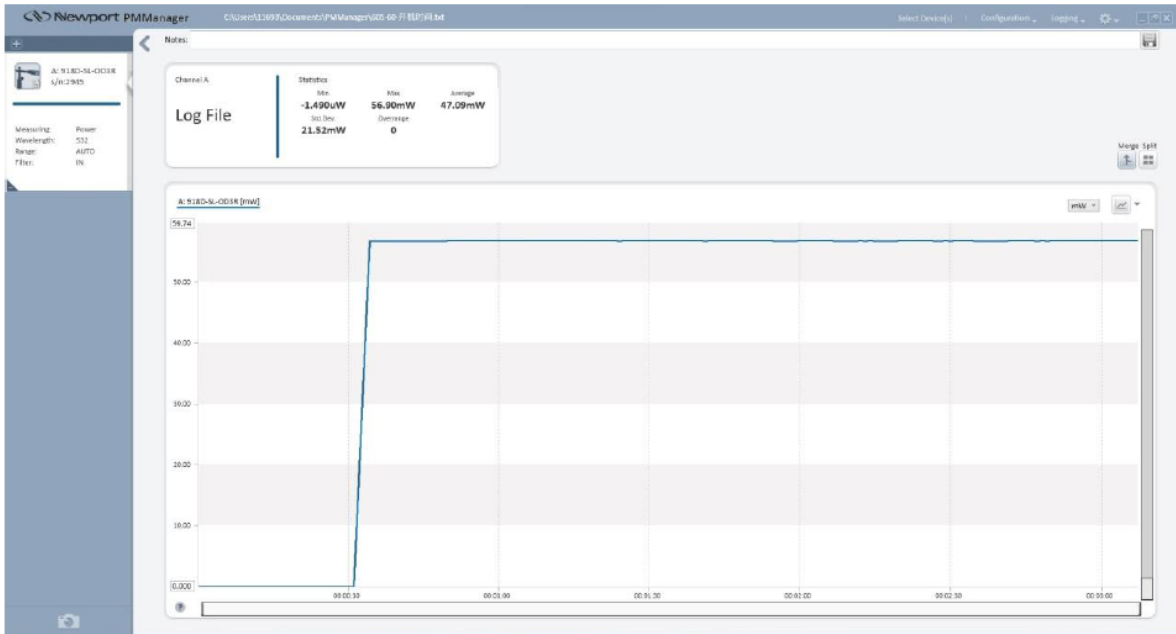

● SLM mode

-40°C

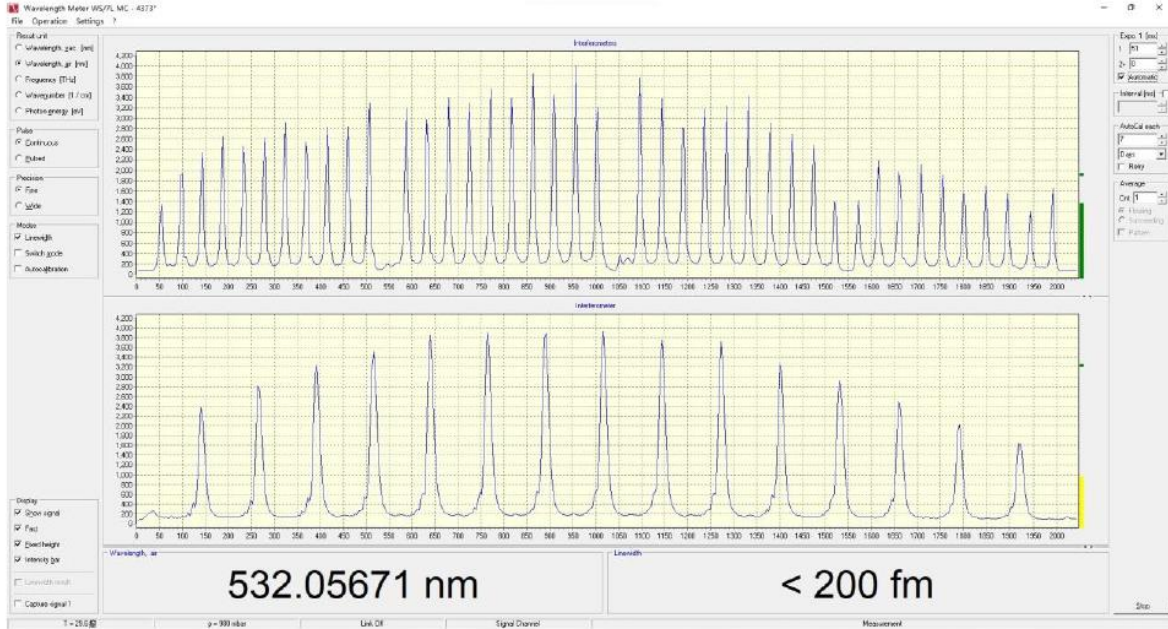

60°C

