

## Package FSLD-TO3-1

### Drawing (all dimensions in mm)

#### Back-View

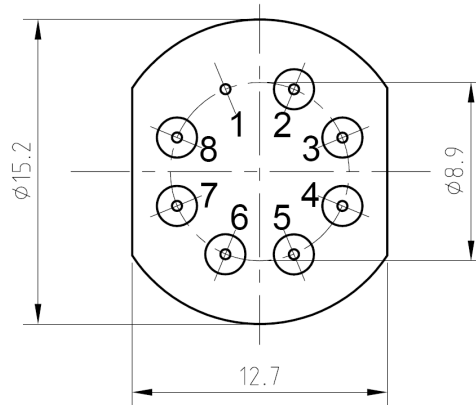

#### Side-View

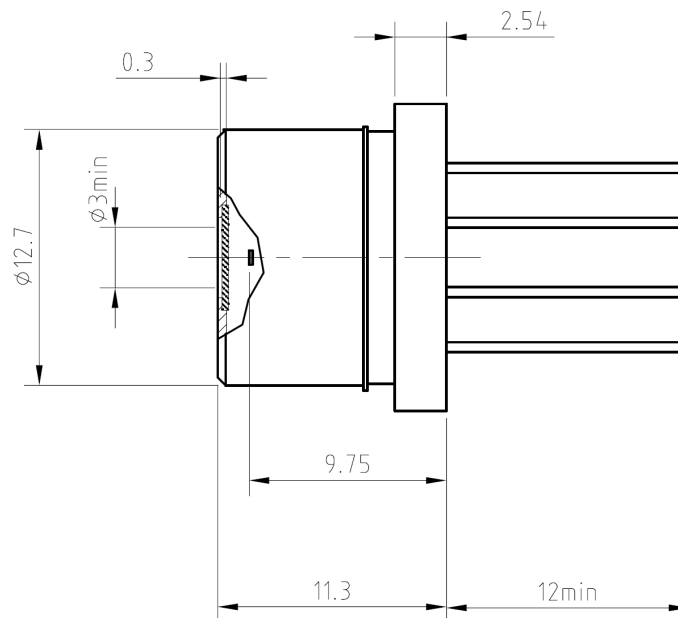

#### Electrical connections

- |                       |                   |
|-----------------------|-------------------|
| 1: PD anode, Case (-) | 5: SLD anode (+)  |
| 2: SLD cathode (-)    | 6: Thermistor     |
| 3: TEC (-)            | 7: Thermistor     |
| 4: TEC (+)            | 8: PD cathode (+) |