



FBLD-940-200W-FC200

Fiber-coupled High Power Diode Laser

Optical data	
Output power	200W CW
Center wavelength λ	940nm
Tolerance of λ	$\pm 10\text{nm}^*$
Spectral Width	5nm
Temperature drift of λ	0.3nm/°C
Spectral Shift with Current	$\sim 1\text{nm/A}$
Electrical data	
Threshold current	0.8A
Operation current	13A
Conversion efficiency η	48%
Slope efficiency	16W/A
Operation voltage	34V
Temperature conditions	
Operation Temperature (Base of Laser Housing)	20-30°C
Storage temperature	-20 ~ +70°C
Feedback Isolation	
Wavelength Range	1030 – 1200 nm
Isolation	>30dB
Optical Fiber	
Fiber diameter	200 μm^*
N.A.	0.22*
Connector	Bare fiber or SMA-905
Fiber length	0.7m*
Other parameters	
Lead Soldering Temperature	260°C (10sec)

* Other specifications available on request

Typ. Spectrum (T=25°C)

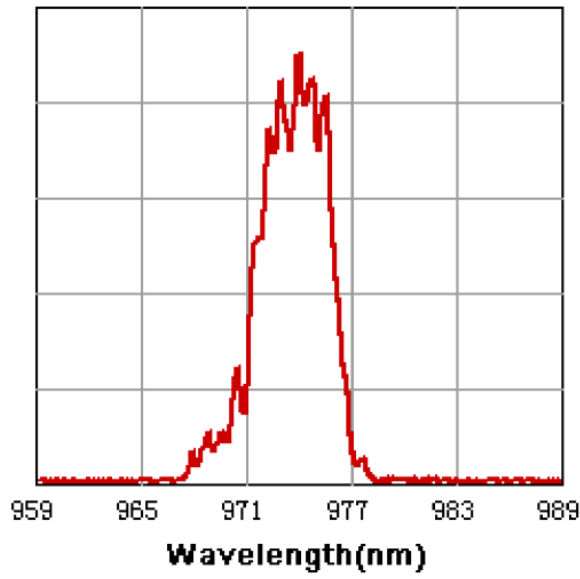

Voltage / Power vs. Current (T=25°C)

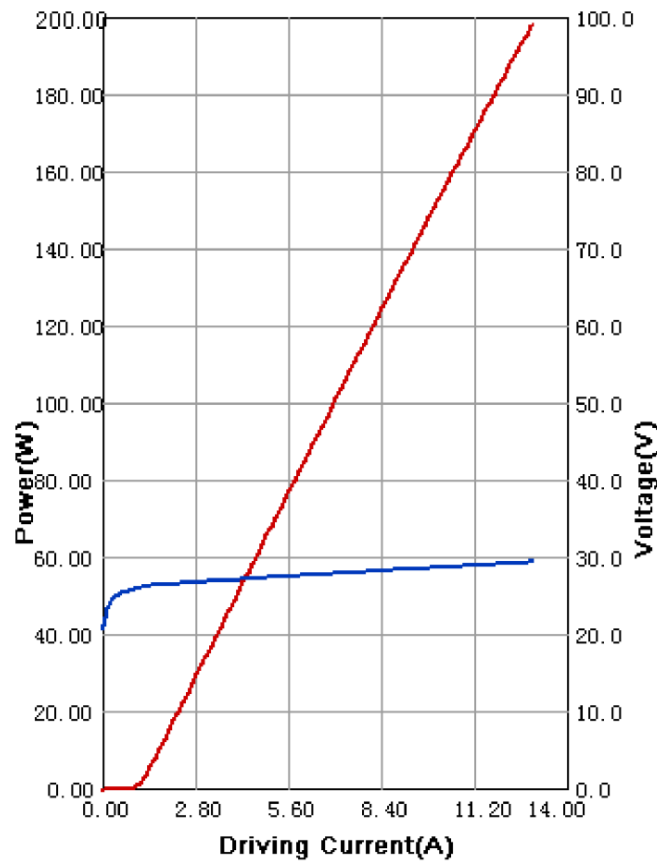

Package Dimensions (mm)

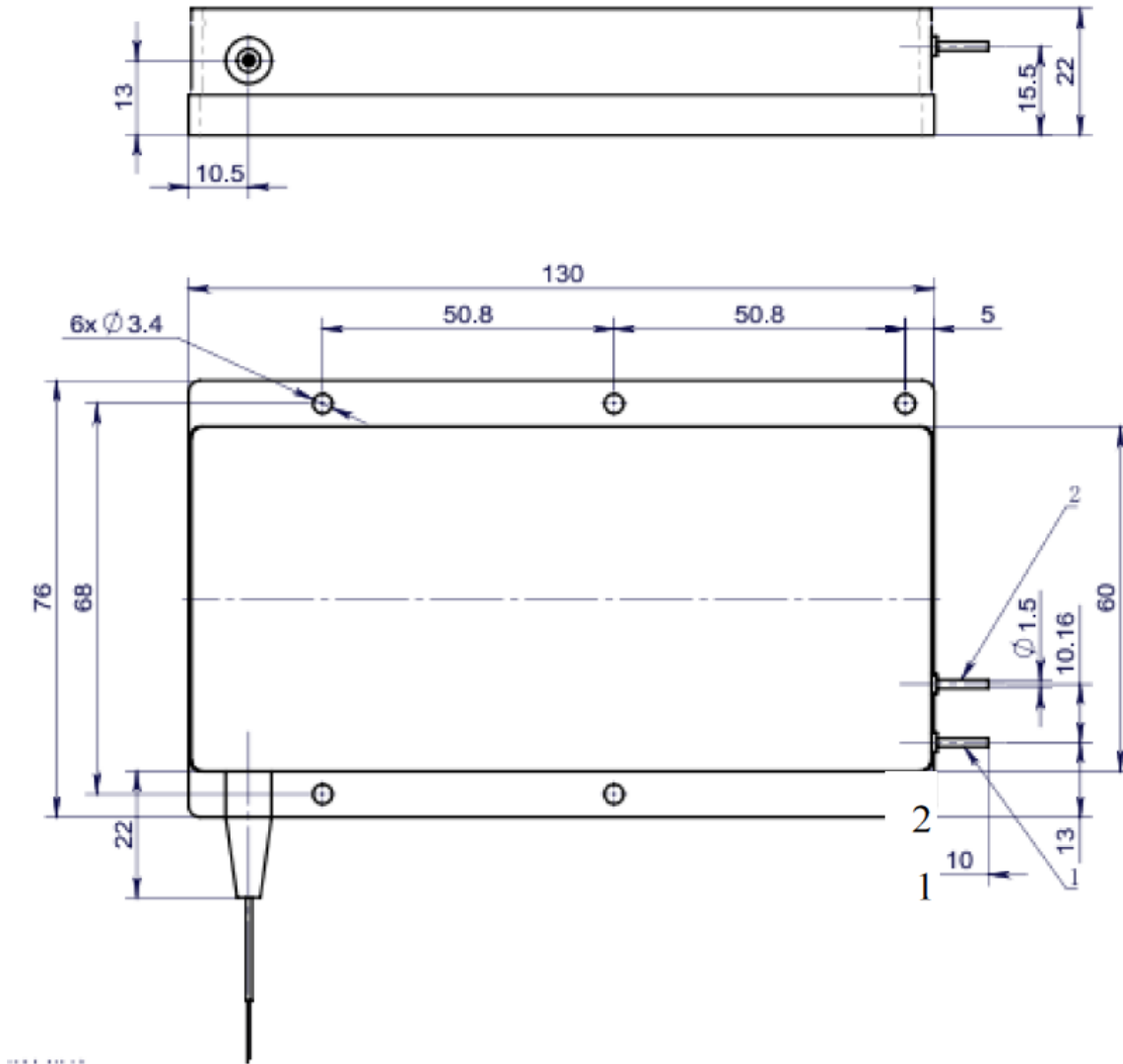

Pin	Function
1	LD (+)
2	LD (-)