

FRLD-1535-300 μ J-Q

Erbium Glass Laser

Applications

- Laser Range Finder
- Metrological Radar

Key Features

- Passively Q-Switched, Er:Glass
- Eye-safe
- Compact Design
- Wide Operating Temperature Range

Specifications

Wavelength (nm)	1535
Pulse Energy (μ J)	300
Pulse Width (FWHM) (ns)	≤ 5
Pulse Repetition Rate (Hz)	10
Beam Divergence (mrad)	10 (typical)
Transversal Mode	TEM ₀₀
Operating Temperature ($^{\circ}$ C)	-40~+65
Storage Temperature ($^{\circ}$ C)	-55~+80
Operating Current (A)	12
Dimensions (mm)	25 x 8 x 7 (LxBxH)
Weight (g)	12

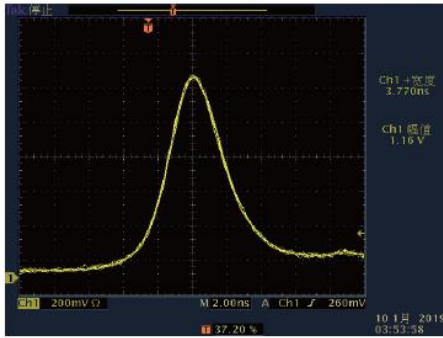

Typical Pulse

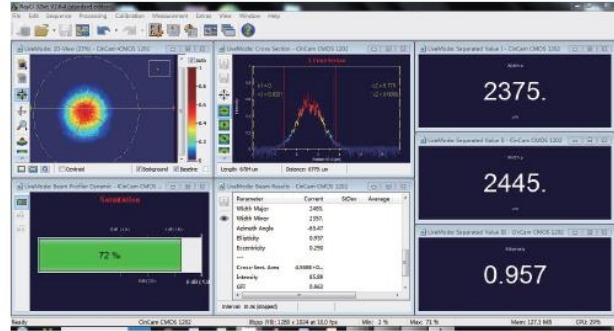

Beam Profile

Drawing

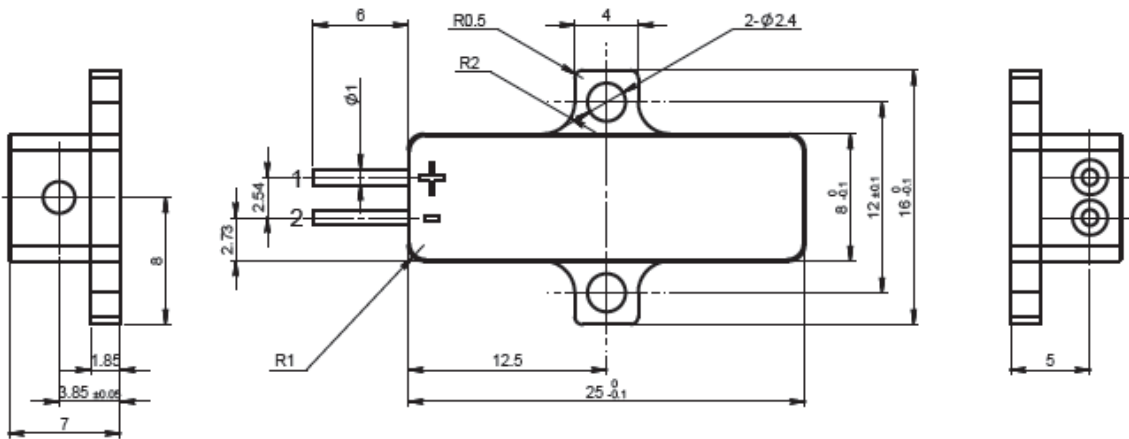

25x8x7mm F2 Drawing

Pin Descriptions

Pin	Function
1	Laser (+)
2	Laser (-)