

# FRLD-785-500-FS-VBG-BTF

## Free Space Narrow Linewidth Laser Diode

**Applications:** Raman Spectroscopy  
 Medical  
 Spectrum Analysis  
 Scientific Research

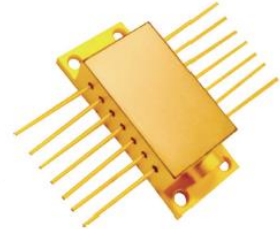

Specifications	Unit	Min	Typ	Max
<b>Optical Data</b>				
CW Output Power	mW	500	-	-
Center Wavelength $\lambda$	nm	784.5	785.0	785.5
Spectral Width (FWHM)	nm	-	-	0.1
Temperature Drift of $\lambda$	nm/°C	-	0.01	-
Current Drift of $\lambda$	nm/A	-	0.05	-
<b>Electrical Data</b>				
Threshold Current	A	-	0.4	-
Operation Current	A	-	1.1	-
Operation Voltage	V	-	2.0	-
Slope Efficiency	W/A	-	0.7	-
<b>PD Data</b>				
Current	$\mu$ A	-	-	2000
<b>Thermistor</b>	k $\Omega$ / $\beta(25^\circ)$	10 $\pm$ 5% / 3450		
<b>TEC Data</b>				
Max. Current	A	-	-	2.5
Max. Voltage	V	-	-	6.3

Specifications	Unit	Min	Typ	Max
<b>Temperature Conditions</b>				
Case Operation Temperature	°C	10	-	30
Storage Temperature	°C	-20	-	70
<b>Other Parameters</b>				
Lead Soldering Temperature	°C	-	-	250
Lead Soldering Time	sec	-	-	10
Relative Humidity (Operating)	%	-	-	75
Relative Humidity (Storage)	%	-	-	90

### Package Dimensions (mm)

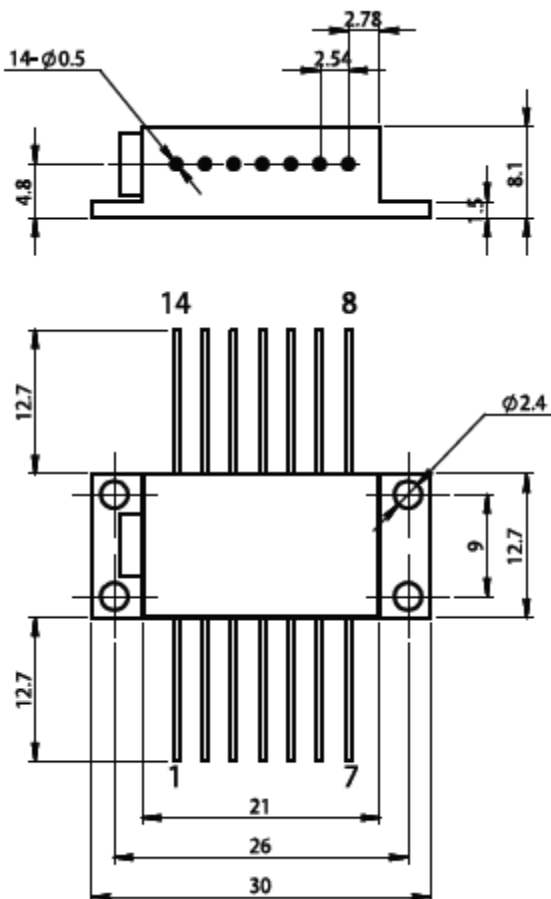

Pin	Function	Pin	Function
1	TEC (+)	8	-
2	Thermistor	9	-
3	PD(P)	10	Laser (+)
4	PD(N)	11	Laser (-)
5	Thermistor	12	-
6	-	13	Case
7	-	14	TEC (-)