

FRLD-830-600-FS-VBG-BTF

Free Space Narrow Linewidth Laser Diode

Applications: Raman Spectroscopy
 Medical
 Spectrum Analysis
 Scientific Research

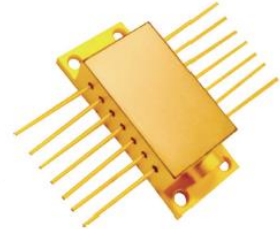

Specifications	Unit	Min	Typ	Max
Optical Data				
CW Output Power	mW	600	-	-
Center Wavelength λ	nm	829.5	830.0	830.5
Spectral Width (FWHM)	nm	-	-	0.1
Temperature Drift of λ	nm/°C	-	0.01	-
Current Drift of λ	nm/A	-	0.05	-
Electrical Data				
Threshold Current	A	-	0.4	-
Operation Current	A	-	1.1	-
Operation Voltage	V	-	1.8	-
Slope Efficiency	W/A	-	0.8	-
PD Data				
Current	μ A	-	-	2000
Thermistor	k Ω / $\beta(25^\circ)$	10 \pm 5% / 3450		
TEC Data				
Max. Current	A	-	-	2.5
Max. Voltage	V	-	-	6.3

Specifications	Unit	Min	Typ	Max
Temperature Conditions				
Case Operation Temperature	°C	10	-	30
Storage Temperature	°C	-20	-	70
Other Parameters				
Lead Soldering Temperature	°C	-	-	250
Lead Soldering Time	sec	-	-	10
Relative Humidity (Operating)	%	-	-	75
Relative Humidity (Storage)	%	-	-	90

Package Dimensions (mm)

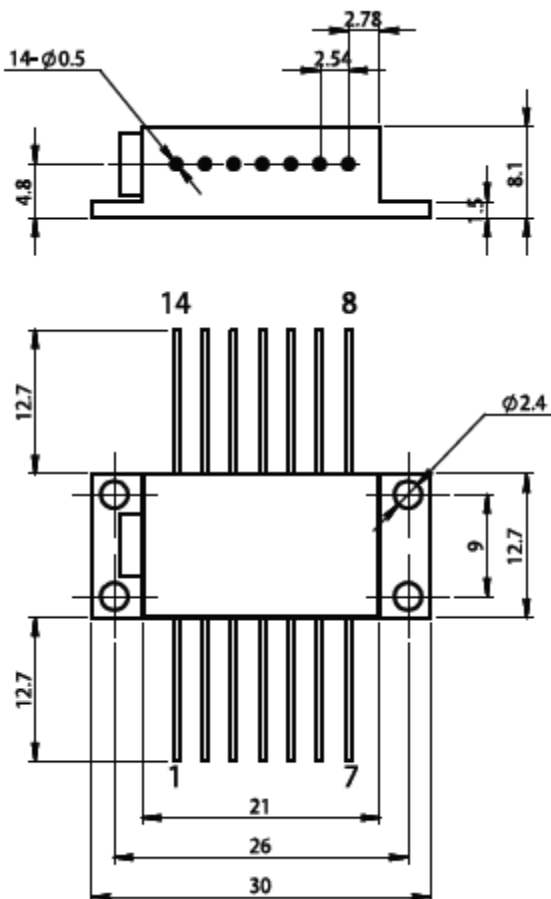

Pin	Function	Pin	Function
1	TEC (+)	8	-
2	Thermistor	9	-
3	PD(P)	10	Laser (+)
4	PD(N)	11	Laser (-)
5	Thermistor	12	-
6	-	13	Case
7	-	14	TEC (-)